

Ficha técnica

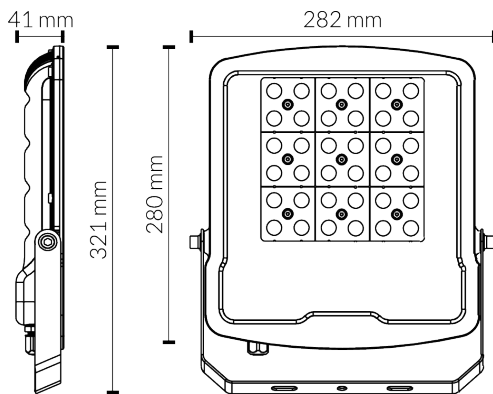

145lm/W

CÓDIGO	POTENCIA	LUMENES	TENSIÓN
561000390NW	100W	14300lm	175-265V

ESPECIFICACIONES TECNICAS

Tipo de óptica	Óptica simétrica 90°
Temperatura color	4000K
IRC	>80
Led chip	Lumileds SMD 2835
Temperatura de Trabajo	-20°/50°
Material	Aluminio
Acabado	Negro
Dimensiones	282x321x41 mm
Certificados	CE&Rohs
Horas de vida	55.000 h
Peso	1,72 kg

